

# Monitoring and Control of Action by the Frontal Lobes

## Review

Jeffrey D. Schall,<sup>1,3</sup> Veit Stuphorn,<sup>1</sup>  
and Joshua W. Brown<sup>2</sup>

<sup>1</sup>Center for Integrative and Cognitive Neuroscience  
Department of Psychology  
Vanderbilt University  
Nashville, Tennessee 37203

<sup>2</sup>Department of Psychology  
Washington University  
St. Louis, Missouri 63130

Success requires deciding among alternatives, controlling the initiation of movements, and judging the consequences of actions. When alternatives are difficult to distinguish, habitual responses must be overcome, or consequences are uncertain, deliberation is necessary and a supervisory system exerts control over the processes that produce sensory-guided movements. We have investigated these processes by recording neural activity in the frontal lobe of macaque monkeys performing a countermanding task. Distinct neurons in the frontal eye field respond to visual stimuli or control the production of the movements. In the supplementary eye field and anterior cingulate cortex, neurons appear not to control directly movement initiation but instead signal the production of errors, the anticipation and delivery of reinforcement, and the presence of processing conflict. These signals form the core of current models of supervisory control of sensorimotor processes.

### Introduction

A central goal of neuroscience is to explain how behavior and psychological processes come from neural mechanisms. This problem is particularly acute when it involves decision making for voluntary behavior because the stakes are no less than understanding the physical basis of human action (e.g., Kane, 1996; Kim, 1998; Juarrero, 1999). Voluntary control over behavior starts with the ability to decide between alternatives. Neural concomitants of deciding between alternative stimuli and responses have been reviewed (e.g., Schall and Thompson, 1999; Glimcher, 2001; Gold and Shadlen, 2001; Schall, 2001; Gold and Shadlen, 2002 [this issue of *Neuron*]). Even in the absence of alternative responses, one can choose between moving and not moving. Thus, the control of action also entails understanding how movements are initiated and how partially prepared movements are canceled.

A choice is judged as good or bad according to whether a goal was achieved. Therefore, another critical element of decision making is evaluating the consequences of previous actions. Hence, we must also understand how the brain detects the consequences of actions to influence subsequent actions. Such evaluative signals are intimately related to reward signals. A positive evaluation would include the anticipation and

receipt of rewarding stimuli, whereas a negative evaluation would include either omission of an expected reward or delivery of an aversive stimulus (Rolls, 1999). The outcome of this evaluation process should lead to an adjustment in behavior that improves the chances of future success. Such a system would implement a form of reinforcement learning (e.g., Sutton and Barto, 1998) which has been linked to the dopamine system of the brain (e.g., Schultz et al., 1997; Brown et al., 1999; Schultz, 2002 [this issue of *Neuron*]).

Sensitivity to reinforcement allows an organism to act in accordance with regularities in the environment. This sensitivity can be expressed through mechanisms intrinsic to sensorimotor neural systems. Intrinsic means of adapting to regularities in the environment include priming in the sensory and motor neural pathways that bias for or against repeated responses. For example, the response times of macaque monkeys producing eye movements to visual stimuli vary as movements are repeated or alternate, and this sequentially ordered performance is associated with changes in the neural activity in the superior colliculus (Dorris et al., 2000) and frontal eye field (Bichot and Schall, 2002). However, such mechanisms seem insufficient to contend with more complex contingencies. When the environment is ambiguous or presents competing demands, or the mapping of stimulus onto response is complex or contrary to habit making performance prone to errors, then an executive, supervisory system exerts control. Supervisory, executive control over the perception, selection, and production systems is seen as a central component of human cognition (e.g., Logan, 1985; Norman and Shallice, 1986; Cohen et al., 1990; Allport et al., 1994; Baddeley and Della Sala, 1996; Logan and Gordon, 2001).

These questions have been investigated effectively with visually guided eye movements. The neural representation of visual stimuli is very well understood (e.g., Parker and Newsome, 1998) and the processes by which the visual system determines what is where in an image and selects the target for further action have been described in some detail (e.g., Schall and Thompson, 1999; Colby and Goldberg, 1999). In addition, the eye movement production system is very well understood (e.g., Carpenter, 1991; Wurtz and Goldberg, 1989; Scudder et al., 2002). Thus, we know more about and have easier access to every stage of the production of visually guided eye movements than we do for limb or vocal movements. Several lines of evidence indicate that the knowledge gained about the cognitive control of eye movements can generalize to other systems and more complex behaviors. For example, the influence of a waiting period before a target on response time is the same for movements of the eyes (Findlay, 1981; D.P. Hanes et al., 1992, *Soc. Neurosci.*, abstract) as it is for movements of the limbs (e.g., Niemi and Näätänen, 1981). Also, when asked to generate a sequence of saccades, the latency of the first saccade increases with the number of movements in the sequence (Zingale and Kowler, 1987) following the same pattern observed for speech and typing (Sternberg et al., 1978). Finally, the slowing

<sup>3</sup>Correspondence: jeffrey.d.schall@vanderbilt.edu

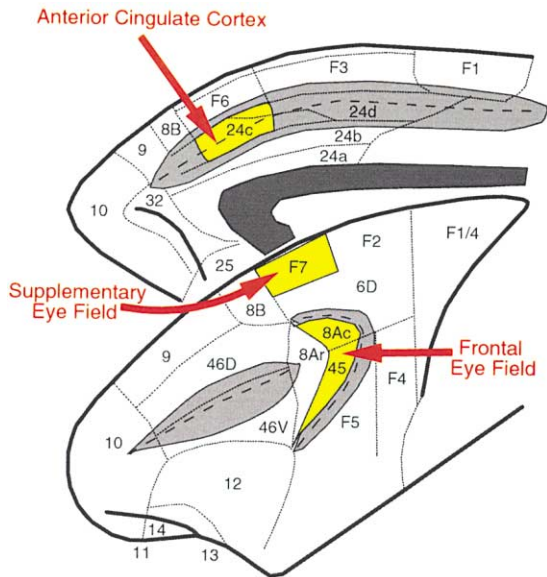

**Figure 1. Anatomical Subdivisions of Macaque Frontal Cortex**  
The dorsolateral (lower) and mesial (upper) surface of the frontal lobe are shown. The location of the frontal eye field (areas 8Ac and 45), supplementary eye field (area F7), and the portion of anterior cingulate cortex connected with the supplementary eye field (in area 24c) are highlighted in yellow. Gray areas represent opened sulci, showing the fundus as a dashed line. Boundaries between labeled areas are indicated by dotted lines.

of responses that has been observed following errors of vocal or manual movements (e.g., Rabbitt, 1966; Rabbitt and Phillips, 1967) has also been observed for saccadic eye movements (J.D. Schall and T.L. Taylor, 1998, Soc. Neurosci., abstract; Cabel et al., 2000). Hence, the most general aspects of the voluntary control of behavior seem to be independent of effector.

### Eye Fields in Frontal Cortex

Before describing our experimental data, we provide some background on the cortical areas from which the data were collected (Figure 1).

The *frontal eye field* (FEF) is an area in prefrontal cortex, located in the rostral bank of the arcuate sulcus in macaque monkeys. Broadly considered, this cortical area participates in the transformation of visual signals into saccade motor commands (reviewed by Schall, 1997). Physiological recordings in the FEF of monkeys trained to shift gaze to visual targets have found that roughly half of the neurons have visual responses (e.g., Mohler et al., 1973; Bruce and Goldberg, 1985). Recent research has demonstrated how these visually responsive neurons in FEF participate in the selection of visual targets for saccades (reviewed by Schall and Thompson, 1999; see also Schall et al., 1995; Thompson and Schall, 1999; Bichot and Schall, 1999a, 1999b; Kim and Shadlen, 1999; Murthy et al., 2001; Sato et al., 2001). FEF is also known to play a direct role in producing saccadic eye movements. Low intensity microstimulation of FEF elicits saccades (e.g., Bruce et al., 1985). This direct influence is mediated by a subpopulation of neurons in FEF that discharge specifically before and during saccades (Bruce and Goldberg, 1985; Hanes and

Schall, 1996). These neurons that generate movement-related activity innervate the superior colliculus (Segraves and Goldberg, 1987; Sommer and Wurtz, 2000) and the neural circuit in the brainstem that generates saccades (Segraves, 1992). Recent work has demonstrated that reversible inactivation of FEF impairs monkeys' ability to make saccades (Dias et al., 1995; Sommer and Tehovnik, 1997) and complements earlier observations that ablation of FEF causes an initial severe impairment in saccade production that recovers over time (e.g., Schiller et al., 1987; Schiller and Chou, 1998).

The *supplementary eye field* (SEF) is an area in dorsomedial frontal cortex that may be considered an ocular motor extension of the supplementary motor area (SMA). In several respects, SEF seems to parallel FEF. Neurons in SEF are responsive to visual or auditory stimulation, and other neurons in SEF discharge in relation to saccades (e.g., Schlag and Schlag-Rey, 1987; Schall, 1991). Other studies have reported more complex functional properties of SEF neurons including conditional motor learning (Chen and Wise, 1995) and object-centered representation (Olson and Gettner, 1995, 1996, 1999; Olson and Tremblay, 2000), production of anti-saccades (Schlag-Rey et al., 1997) and sequences of saccades (Lu et al., 2002), and eye-hand coordination (Mushiaki et al., 1996). Saccades can be elicited by low intensity microstimulation of SEF, but stimulation of at least certain sites in SEF evokes saccades with dimension and direction dependent on the position of the eyes in the orbit (e.g., Schlag and Schlag-Rey, 1987; Tehovnik and Lee, 1993; but see Russo and Bruce, 1996). SEF innervates ocular motor centers in the striatum, superior colliculus, and brainstem (Huerta and Kaas, 1990; Shook et al., 1990, 1991). However, as will be elaborated below, the SEF seems to play a less essential or potent role in saccade production. Indeed, ablation of SEF causes only minimal and short-lasting gaze impairments (e.g., Schiller and Chou, 2000a, 2000b).

The *anterior cingulate cortex* (ACC) is a large and heterogeneous part of the cerebral cortex that can be partitioned based on architecture, connectivity, and functional properties (e.g., Picard and Strick, 1996; Koski and Paus, 2000; Paus et al., 1996; Bush et al., 2000). Recent anatomical, physiological, and neuroimaging experiments indicate that the subdivisions buried in the anterior cingulate sulcus contain at least three different skeletal motor areas (Picard and Strick, 1996; Dum and Strick, 1991; Luppino et al., 1991; Morecraft and Van Hoesen, 1992). In macaque monkeys, the rostral cingulate motor area (CMAR) is located in area 24c, spanning both banks of the cingulate sulcus (Dum and Strick, 1991; Matelli et al., 1993). The other two cingulate motor areas are located caudal to the genu of the arcuate sulcus, at the rostro-caudal level of the SMA proper. The two posterior cingulate motor areas seem to have stronger and more direct connections to the skeletomotor system (Dum and Strick, 1991; Luppino et al., 1991). Several lines of evidence suggest that ACC contributes to ocular motor function. Anatomical studies in monkeys have shown dense, reciprocal connectivity between ACC and SEF (Huerta and Kaas, 1990; Luppino et al., 1990) but a much weaker linkage with the FEF (Huerta et al., 1987; Stanton et al., 1993). Saccadic eye movements can be evoked by electrical microstimulation of a region in the upper bank of the cingulate sulcus directly ventral

to the SEF, in the CMAr of area 24c (Mitz and Wise, 1987; Mitz and Godschalk, 1989). Some involvement of ACC in the cognitive control of ocular motor behavior in normal human subjects has been reported from functional imaging studies (e.g., Paus et al., 1993; Petit et al., 1998; O'Sullivan et al., 1995). Also, two human patients with focal lesions in the ACC exhibited deficits in high order control of gaze (Gaymard et al., 1998).

Single-unit recordings in the ACC of macaques have reported a variety of signals. Some ACC neurons show directional delay activity and activity following errors or omission of reward (Niki and Watanabe, 1976, 1979). Others show activity specific to motor set for self-paced movements (Shima et al., 1991) and to voluntary movement selection based on reward (Shima and Tanji, 1998). Some neurons encode the serial order of movements in sequences and show different activity profiles in trial-and-error exploration and routine performance (Procyk et al., 2000). Indirect measures of neural activity in humans have focused discussions of self-monitoring and self-control on ACC. As described in more detail below, a particular event-related potential is observed when subject make errors that appears to arise in ACC (Dehaene et al., 1994; Miltner et al., 1997). Also, neuroimaging studies have described ACC activation when subjects must inhibit competing responses, apply a new stimulus-response mapping rule, or generate an action under limited or no constraints (reviewed by Posner and DiGirolamo, 1998; Carter et al., 1999; Barch et al., 2000; Botvinick et al., 2001).

### The Countermanding Paradigm

To investigate the neural control of movement initiation and suppression, we have employed the countermanding paradigm with behaving monkeys. Developed to investigate human performance, the countermanding paradigm probes a subject's ability to control the initiation of movements by infrequently presenting an imperative stop signal in a response time task (Logan and Cowan, 1984; reviewed by Logan, 1994). The subject's task is to cancel the planned movement if a stop signal is presented. In the ocular motor version, monkeys were trained to make a saccade to a peripheral target that appeared when the fixation spot disappeared unless a stop signal was presented (Figure 2). In response to the stop signal, the monkeys were to withhold the movement; the stop signal was the reappearance of the fixation spot (Hanes and Schall, 1995). Logan and Cowan (1984) showed that performance on this task can be accounted for by a race between a process that generates the movement (GO process) and a process that cancels the movement (STOP process). This race model provides an estimate of the stop signal reaction time, which is the time needed to cancel the planned movement. The stop signal reaction time corresponds theoretically and quantitatively to estimates of the time needed to reprogram a saccade in double-step saccade tasks (Lisberger et al., 1975; Becker and Jurgens, 1979). Ocular motor stop signal reaction times average around 80–100 ms in monkeys (Hanes and Schall, 1995; Hanes et al., 1998). Several studies have shown that human performance in the saccade countermanding task is quite similar to that of monkeys (Hanes and Carpenter, 1999; Cabel et al., 2000; Logan and Irwin, 2000; Asrress and Carpenter, 2001; Colonius et al., 2001).

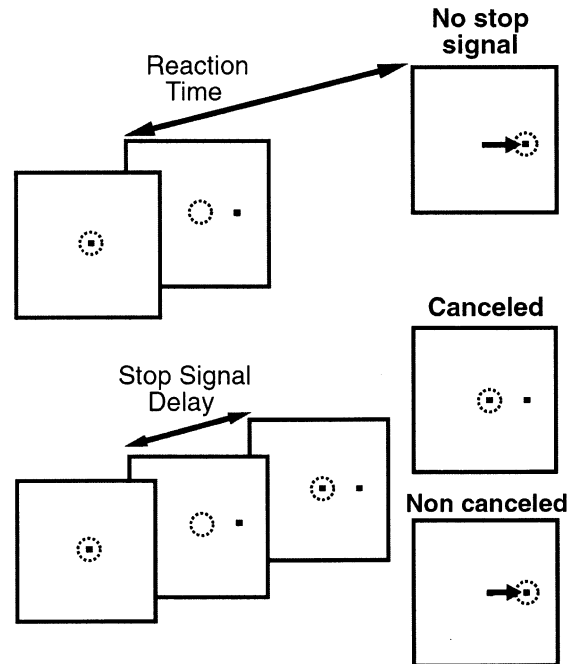

Figure 2. Trial Displays for the Countermanding Task

The dotted circle indicates the focus of gaze at each interval, and the arrow indicates the saccade. All trials began with the presentation of a central fixation spot. After fixation of this spot for a variable interval, it disappeared. Simultaneously, a target appeared at an eccentric location. On a fraction of trials after a delay, referred to as the stop signal delay, the fixation spot reappeared, instructing the monkey to withhold movement initiation (stop signal trials). During the trials in which the stop signal was not presented (no stop signal trials), monkeys were rewarded for generating a single saccade to the peripheral target. During stop signal trials, monkeys were rewarded for maintaining fixation on the central spot for 700 ms (canceled trials). If the monkeys did generate a saccade to the peripheral target during stop signal trials, no reward was given (non-canceled trials).

Both humans and monkeys learn how to perform the countermanding task relatively quickly, but adjustments of performance continue after the task is well learned. Any random sample of consecutive trials will vary in the proportion of stop signal trials—sometimes there are many stop signal trials, and sometimes there are relatively few. Subjects have no a priori guarantee of stationarity in the environment, so they tend to adjust their bias of speed versus accuracy on an ongoing basis. For example, if many stop signal trials occur, it is adaptive to increase response time, i.e., slow down and be more careful, at the cost of waiting longer for reward. It is important to note that this does not involve new learning of the task; rather, it involves controlled adjustment to optimize performance.

We investigated the nature of these control adjustments in both humans and monkeys (J.D. Schall and T.L. Taylor, 1998, *Soc. Neurosci.*, abstract; Hanes and Carpenter, 1999; see also Cabel et al., 2000). In spite of idiosyncrasies across subjects, several trends were evident. First, both humans and monkeys were more likely to cancel a saccade in response to the stop signal if the preceding trial had a stop signal; this tendency was more pronounced in monkeys if they failed to cancel

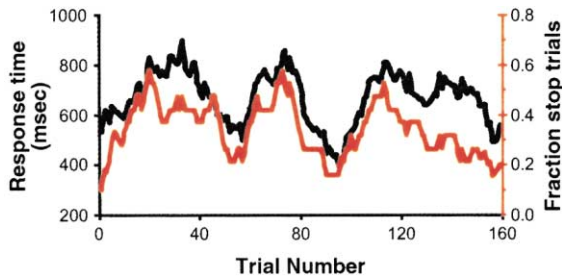

Figure 3. Covariation of the Running Average of Response Time of Monkeys on Trials with No Stop Signal (Black) and the Running Average of the Fraction of Stop Signal Trials (Red)

the saccade in the preceding trial. Second, the probability of canceling a saccade decreased following sequences of trials with no stop signal. Third, overall response time was affected by the trial history; this was manifest as an elevation of response time following sequences of preceding stop signal trials and a smaller and more variable impact of the number of preceding trials with no stop signal. Furthermore, we found that response time correlated significantly with momentary fluctuations in the fraction of stop signals (Figure 3). These results indicate that the response to a given stimulus depends on the context derived from the history of previous trials.

The original behavioral evidence for a supervisory control system emphasized adjustments in response time following errors (e.g., Rabbitt, 1966; Rabbitt and Phillips, 1967). We will review the functional properties of FEF, SEF, and ACC in the context of this framework. Specifically, we hypothesize that FEF is part of the sensorimotor pathway, while the SEF and ACC monitor performance and provide extrinsic control signals.

#### Neural Control of Saccade Initiation by Frontal Eye Field

Response time is characterized by stochastic variability (reviewed by Luce, 1986). The lack of control over the variability of response times was noted early on—“Everyone who makes reaction-time experiments for the first time is surprised to find how little he is master of his own movements...Not only does their energy lie, as it were, outside the field of choice, but even the time in which the movement occurs depends only partly upon ourselves” (Exner, 1873).

To understand the source of the variability of response time, we have investigated movement-related activity recorded in FEF. We found that saccadic eye movements were initiated when movement-related activity in FEF reached a particular level that was idiosyncratic for each neuron but did not vary with response time (Figure 4) (Hanes and Schall, 1996; see also Sparks, 1978; Lecas et al., 1986; Dorris et al., 1997; Everling et al., 1999; Everling and Munoz, 2000). The same observation was made for the magnitude of the lateralized readiness potential, a scalp potential that precedes movements (Gratton et al., 1988). The variability in response time was accounted for mainly by variation in the rate of growth of the pre-movement activity toward the trigger threshold. Thus, the movement-related neural activity

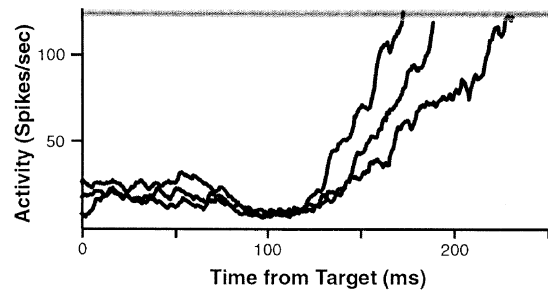

Figure 4. Relationship between Movement-Related FEF Activity and Saccade Initiation

Timecourse of activation of a single movement-related FEF neuron is shown for three subsets of trials having different saccade latencies. Plots are aligned on target presentation and stop at saccade initiation. The level of activity at which the saccade is triggered (gray bar) is constant across saccade latencies. Variability in saccade latency is accounted for by the time taken by the neural activity to reach the threshold activation. (Modified from Schall and Thompson, 1999.)

in FEF appears to correspond to an accumulator architecture with variable growth to a fixed threshold (e.g., Ratcliff, 1978; Carpenter, 1988; Carpenter and Williams, 1995; Ratcliff et al., 1999; Reddi and Carpenter, 2000). The origin of the variability in the growth of activity is not known; perhaps it can be accounted for at least in part by the state of neuromodulatory systems (e.g., Aston-Jones et al., 1994).

Although this result indicates how the variability of saccade initiation times can be accounted for by the activation of neurons in the ocular motor pathway, the results do not explain the ability of a subject to control saccade production. A critical characteristic of voluntary control is the ability to withhold planned movements. Thus, can saccades be partially prepared but not executed? If so, then what do the neurons that produce a movement do when the movement is canceled because of the stop signal? The chief virtue of the countermanding paradigm is that one can determine whether single neurons generate signals that are sufficient to control the production of movements. The logic of the countermanding paradigm establishes two criteria a neuron must meet to play a direct role in the control of movement. First and most obviously, the neuron must discharge differently when a saccade is initiated versus when a saccade is withheld. Second and most importantly, this difference in activity must occur by the time that the movement is canceled, i.e., within the stop signal reaction time.

Movement-related activity in FEF which began to grow toward the trigger threshold failed to reach the threshold activation level when movements were canceled (Figure 5A) (Hanes et al., 1998). Instead, when planned movements were canceled, the movement-related activity decreased rapidly after the stop signal was presented. Moreover, the movement-related activity associated with canceling as compared to executing the movement became different just before the stop signal reaction time had elapsed. Therefore, the activity of single FEF movement neurons is logically sufficient to specify whether or not a saccade will be produced.

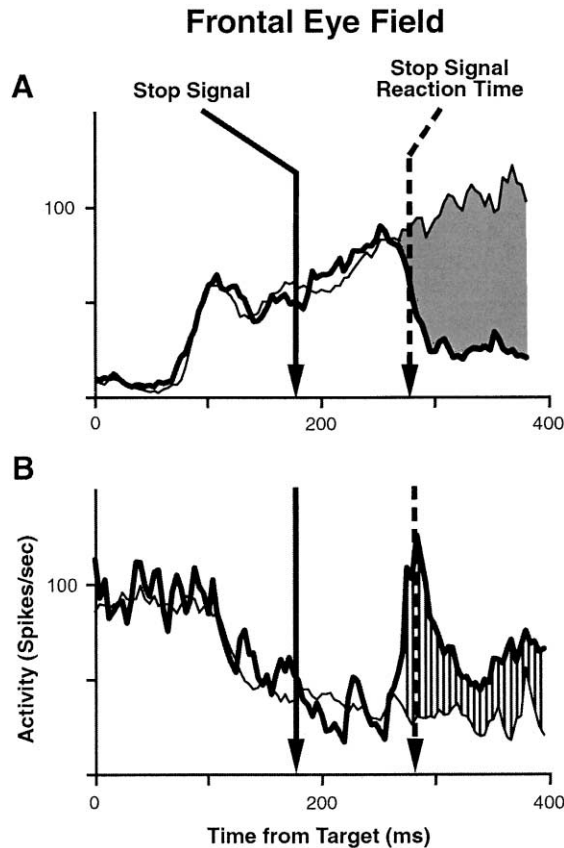

Figure 5. Relationship between FEF Neural Activity and Canceling a Movement

(A) Activity of a movement neuron in FEF in trials in which the movement was produced but would have been canceled if the stop signal had been presented (thin line) is compared with activity on trials when the planned saccade was canceled because the stop signal appeared (thick line). The time of the stop signal is indicated by the solid vertical arrow. The time needed to cancel the planned movement—stop signal reaction time—is indicated by the dashed vertical arrow. When the movement was canceled, neural activation decayed precipitously immediately before the stop signal reaction time. This modulation within the stop signal reaction time demonstrates that this neuron conveys a signal sufficient to control whether the eyes move. (B) Comparison of the activity of a fixation neuron in FEF when saccades were initiated or canceled. The discharge rate of this neuron decreased before and during saccades. When the saccade was canceled, the activation increased sharply before the stop signal reaction time. (Modified from Hanes et al., 1998.)

This pattern of results was observed in almost all cells with movement-related activity.

A complementary pattern of neural activity was observed in another class of neuron in FEF called fixation neurons (Figure 5B). If eye movements were canceled, fixation neurons that had decreased firing generated a rapid burst of activity before the stop signal reaction time. The modulation before the stop signal reaction time was never observed in neurons with only visual responses. The different results observed for the different functional classes of neurons is entirely consistent with the fact that movement and fixation neurons in FEF provide direct input to the brain structures that produce eye movements (Segraves and Goldberg, 1987;

Segraves, 1992; Sommer and Wurtz, 2000). Preliminary results indicate that the activity in the superior colliculus of monkeys performing the ocular motor countermanding task is qualitatively similar to that in FEF (D.P. Hanes and M. Paré, 1998, Soc. Neurosci., abstract).

While it is clear that the activation of many neurons in a circuit including the FEF, the superior colliculus, basal ganglia, thalamus, cerebellum, and brainstem contributes to the production of each saccade (e.g., Lee et al., 1988; Wurtz et al., 2001), the activity of a single neuron is not *necessary* for movement production. On the other hand, in the countermanding task, the activity of a single movement neuron in the FEF or superior colliculus appears to be *sufficient* to account for whether and when movements are produced. How can this be? Many studies have shown that movement-related neurons in FEF, superior colliculus, and other structures are active in the same way at the same time before eye movements. These structures are interconnected with short (2-3 ms) transmission lags (Segraves and Goldberg, 1987; Sommer and Wurtz, 2000). For any single neuron to be highly correlated with behavior even though no single neuron is necessary to produce behavior, it has been hypothesized that the relevant pools of neurons within and across structures contributing to a behavior have coordinated activity. Evidence for such coordination has been obtained in areas supporting visual discrimination and search (e.g., Shadlen et al., 1996; Bichot et al., 2001).

Given the well-known variability of neural discharge, how many neurons must contribute to predict the initiation of a saccade? We have carried out an analysis and simulation to determine how reliably the activity of FEF neurons from multiple trials from the same or different neurons predicts movement initiation (J.W. Brown et al., 2001, Soc. Neurosci., abstract). We found that the activity of around 10 movement-related FEF cells is sufficient to predict saccade initiation with 95% accuracy.

The findings from FEF using the countermanding paradigm indicate that the preparation of a movement can be a controlled process; it can be canceled if the growth of the activation toward the trigger threshold is sufficiently slow. What if errors are made because the movement is not canceled? We found that FEF neurons that are involved in producing an eye movement discharge in the same fashion for errant saccades made even though the stop signal was presented as for correct saccades made when no stop signal was presented. To perform the task well, though, subjects must know when errors are made and adapt their behavior to minimize future errors. Thus, some part of the brain must monitor the consequences of action to adjust performance.

#### Performance Monitoring by Supplementary Eye Field and Anterior Cingulate Cortex

We have recorded neural activity in the SEF and ACC of monkeys performing the saccade countermanding task (V. Stuphorn and J.D. Schall, 2000, Soc. Neurosci., abstract; Stuphorn et al., 2000). Despite the numerous parallels in anatomical connections, neuronal activation profiles, and stimulation effects observed for SEF and FEF (reviewed by Schall, 1997), we have found that, unlike their counterparts in FEF, remarkably few neurons

### Supplementary Eye Field

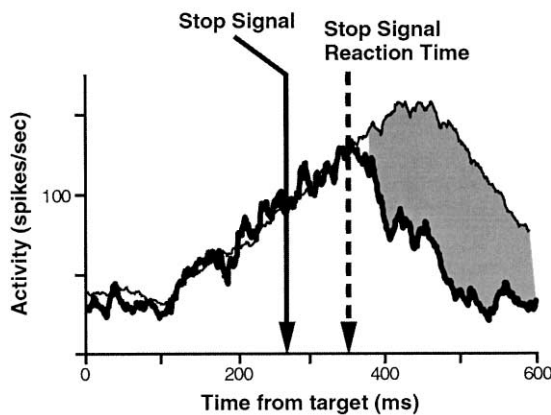

Figure 6. Relationship between SEF Neural Activity and Canceling a Movement

Activity of an apparent pre-movement neuron in SEF in trials in which the movement was produced but would have been canceled if the stop signal had been presented (thin line) is compared with activity on trials when the planned saccade was canceled because the stop signal appeared (thick line). Conventions as in Figure 5. The activity when the movement was canceled decayed *after* the stop signal reaction time, too late to play any role in canceling the movement.

in SEF generate signals that are sufficient to control gaze (J.W. Brown et al., 2001, Soc. Neurosci., abstract). Specifically, neurons in SEF that are modulated in association with saccade production do not exhibit a reliable threshold and when planned movements are canceled, their activity is modulated only *after* the stop signal reaction time has passed (Figure 6). Thus, neurons in SEF that appear to be activated in relation to production of a movement are modulated too late to play a direct role in canceling a planned saccade. These observations are consistent with observations that lesions of SEF cause only a relatively modest impairment of gaze (Schiller and Chou, 1998). On the other hand, following combined ablation of the FEF and the superior colliculus, leaving the SEF intact, monkeys cannot produce saccadic eye movements (Schiller et al., 1980).

Instead of signals controlling gaze, we found distinct groups of neurons in SEF that were active after errors, after successful withholding of a partially prepared movement, or in association with reinforcement. These three forms of activation could not be explained by sensory or motor factors, so we interpret them as evaluative signals.

#### Error-Related Activity

Certain neurons observed in both SEF and ACC exhibit modulation specifically in trials in which a planned movement is not canceled so that reward was not delivered (Figure 7). We interpret this modulation as signaling an error. These neurons did not modulate when rewarded saccades were made on trials with no stop signal, nor were they modulated in stop signal trials resulting in a successfully canceled movement or in relation to delivery of reinforcement. The latency of this

### Supplementary Eye Field

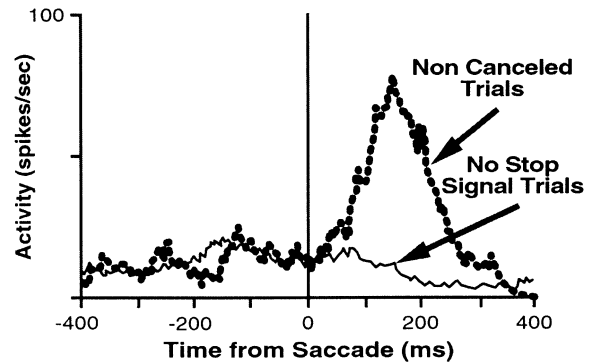

Figure 7. Error-Related Neural Activity

Comparison of activity of an SEF neuron between trials when the eye movement was made because no stop signal was given (thin line) and trials when the eye movement was made in spite of the stop signal (thick dashed line). This neuron discharged following errant, non-canceled saccades but not correct saccades in trials with no stop signal. (Modified from Stuphorn et al., 2000.)

error signal relative to the movement was not different between SEF and ACC.

One of the motivations for interpreting this signal from single neurons in terms of error detection is its correspondence with a particular event-related potential. This signal from single neurons corresponds to a scalp potential referred to as the error-related negativity (ERN) because it occurs when subjects produce errors (e.g., Falkenstein et al., 1991; Gehring et al., 1993; Coles et al., 1995). This event-related potential was the earliest physiological signature of a supervisory control system. Current evidence suggests that the ERN corresponds to the detection but not necessarily the correction of errors (Miltner et al., 1997; Scheffers et al., 1996; Falkenstein et al., 1995). The source generator of the ERN seems centered in the ACC but may include the supplementary motor area located dorsal to ACC (Dehaene et al., 1994; Miltner et al., 1997). Such a distributed source is consistent with our observation that the error signal arises concomitantly in ACC and SEF.

#### Reinforcement-Related Activity

On trials with no stop signal, monkeys received positive reinforcement following an accurate saccade to the target. On trials with a stop signal, monkeys earned reinforcement when the partially prepared saccade to the target was canceled and fixation was maintained. Thus, the countermanding task provides a novel dissociation of behavior from reinforcement. Identical actions (saccades to the target) can yield different outcomes (successful no stop signal trials or unsuccessful non-canceled trials). Conversely, different actions (saccades when no stop signal was presented or holding fixation when the stop signal was presented) lead to the same outcome (reinforcement). These conditions permit the distinction between neuronal signals related to producing the behavioral response and those related to the reinforcement of that response.

We observed other neurons in SEF and ACC that were

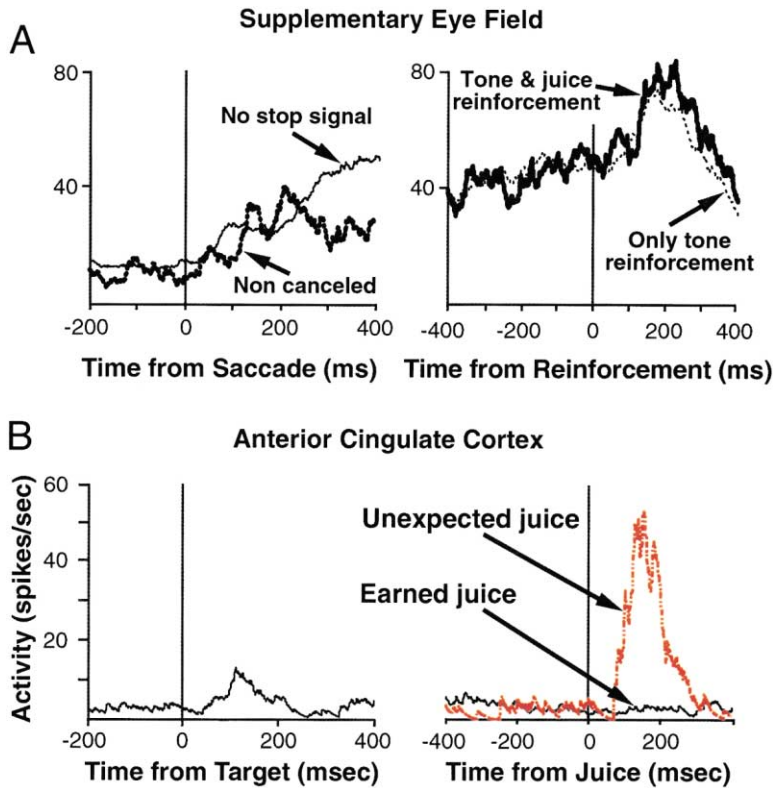

Figure 8. Reinforcement-Related Neural Activity

(A) Activation of an SEF neuron grew after successful no stop signal trials (thin line) but was reduced in non-canceled trials (thick dotted line). Right—Activation was elevated while the monkey awaited reinforcement and peaked after delivery of primary plus secondary (thick) or only secondary (thin) reinforcement. (Adapted from Stuphorn et al., 2000.) (B) Activation of an ACC neuron following delivery of free, unexpected juice but not earned juice as well as a weak apparent response to the visual target.

active specifically after rewarded trials with no stop signal or trials with a stop signal in which the partially prepared saccades were successfully canceled (Figure 8). These neurons exhibited gradually elevated discharge rate before the reinforcement and an additional modulation following receipt of the reinforcement. To extend the performance of monkeys, primary juice reinforcement was delivered on only a fraction of successful trials, but a secondary tone reinforcement was delivered on every successful trial. The neurons in SEF were modulated equivalently when only the secondary, as well as when the primary, reinforcer was delivered. This neural concomitant of the anticipation and receipt of reinforcement seems qualitatively different from the modulation of sensorimotor activity according to reinforcement amount or probability that has been reported in other cortical areas (e.g., Platt and Glimcher, 1999) or the basal ganglia (Kawagoe et al., 1998). Instead, we interpret the activation of these neurons as a direct signal of the receipt of reinforcement. This interpretation is supported by the fact that previous studies have identified neural activity with reinforcement in SEF (Amador et al., 2000) and ACC (Niki and Watanabe, 1979). This type of SEF neuron represents a functional complement of the error-related neurons, signaling the expectation and receipt of reinforcement.

The population of reinforcement-related neurons in ACC was more diverse than that observed in SEF. Some resembled the neurons recorded in SEF, responding to the secondary tone reinforcer as well as to the primary juice reinforcer. However, other neurons in ACC responded only to the primary juice reward both when it was earned and when it was delivered unexpectedly,

but not to the secondary reinforcer. Also, unlike what we observed in SEF, still other ACC neurons responded only to noncontingent, unexpected juice reward (Figure 8B). In fact, some of these also showed an apparent visual response. This pattern of activity resembles the signals produced by brainstem dopamine neurons (e.g., Schultz and Dickinson, 2000). Taken together, these results imply that the reinforcement signal in SEF is more abstract while that in ACC is more closely related to the properties of the reinforcer.

#### Conflict-Related Activity

Yet another population of neurons in SEF exhibited elevated discharge rate during stop signal trials in which the saccade was correctly canceled, but the activity occurred after the stop signal reaction time had elapsed (Figure 9). This modulation cannot be involved in canceling the movement because it occurred too late, so its interpretation is less straightforward. We have been guided in the interpretation of this modulation by the hypothesis that the medial frontal cortex monitors the conflict that arises when mutually incompatible processes are activated simultaneously but cannot both run to completion (e.g., Carter et al., 1998, 1999; Botvinick et al., 2001). This hypothesis has been suggested as an alternative to the claim that the medial frontal lobe only detects errors.

During the saccade countermanning task, gaze-shifting and gaze-holding neurons are activated concurrently when movements are canceled but not when the movements fail to be canceled (D.P. Hanes and M. Paré, 1998, Soc. Neurosci., abstract; Hanes et al., 1998). Because they are mutually incompatible, coactivation of the gaze-

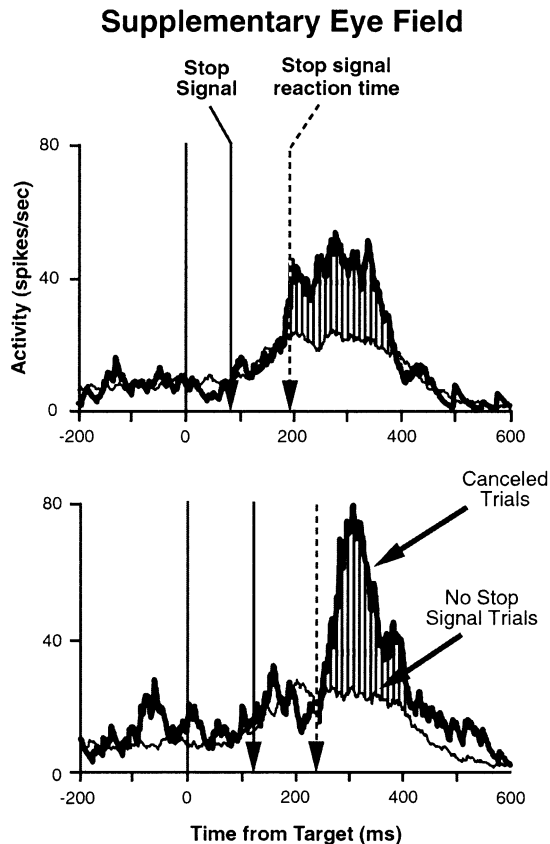

Figure 9. Conflict-Related Neural Activity

Comparison of activity between trials when the movement was canceled (thick line) and trials when the movement was produced but would have been canceled if the stop signal had been presented (thin line). The top panel shows data from shorter stop signal delays in which the monkey canceled the movement on 97% of the stop signal trials. The lower panel shows data from longer stop signal delays in which the monkey canceled the movement on 45% of the stop signal trials. The time of the stop signal and the estimated stop signal reaction time are shown. This neuron was activated *after* the movement was canceled, so the modulation could not play a direct role in canceling the movement. The magnitude of activation increased with decreasing probability of canceling the movement paralleling the amount of coactivation of movement-related and fixation neurons in the FEF and superior colliculus. (Adapted from Stuphorn et al., 2000.)

holding and gaze-shifting systems engenders conflict according to the hypothesis; the magnitude of the conflict should be proportional to the magnitude of the activation of the gaze-holding and gaze-shifting neuron pools. Now, note that the probability of canceling a planned eye movement in the countermanding task is dictated by the balance of activation of gaze-holding and gaze-shifting neurons because movements are canceled only if the gaze-shifting activation does not reach the threshold to trigger the movement because it is countered by the gaze-holding activation. Thus, the probability of failing to cancel a partially prepared saccade increases as gaze-shifting activation grows. Accordingly, as the probability of failing to cancel the movement increases, the combined magnitude of gaze-shifting and gaze-holding activation sufficient to cancel

a planned movement will be higher, resulting in more conflict.

This measure of processing conflict corresponds to the variation in the magnitude of the neural modulation observed in these SEF related to performance (Stuphorn et al., 2000). Of course, this interpretation should be regarded as tentative until further work excludes alternatives. Still, if true, it provides a means of reconciling alternative views of medial frontal function in terms of error detection and conflict detection. However, to date, we have not observed clear examples of neurons signaling this form of conflict in the ACC. In summary, the observations we have made in SEF are unexpected and much more research is needed to reconcile the hypothesis that SEF participates in monitoring performance with the observations for participation of SEF in producing saccades in other tasks reviewed above.

#### Origins of Monitoring Signals

If SEF and ACC carry signals related to correct and errant performance that are not observed in FEF, what is the origin of the difference? Neural activity associated with the receipt, withholding, or unexpected delivery of reward has been recorded in the dorsal and ventral striatum (Shidara et al., 1998; Kawagoe et al., 1998; Schultz, 1997), dorsolateral prefrontal cortex (Watanabe, 1996), orbital frontal cortex (Thorpe et al., 1983), in ACC (Shima and Tanji, 1998; Niki and Watanabe, 1976; Gamba et al., 1986), and in dopamine neurons in the ventral tegmental area and substantia nigra (Schultz, 1997, 1998). The presence of reward-related activation in medial more than lateral frontal cortex may be related to the medial-to-lateral decrease of dopaminergic innervation in the frontal cortex (Williams and Goldman-Rakic, 1998). Furthermore, FEF and SEF seem to receive input from different populations of dopamine neurons in the brainstem (Gaspar et al., 1992); SEF is more heavily innervated by the ventral tegmental area than by the substantia nigra pars compacta; in contrast, FEF is more heavily innervated by the substantia nigra pars compacta than by the ventral tegmental area. Some neurophysiological studies have reported a slightly higher incidence of reward-related activity in the ventral tegmental area as compared to the other dopamine cell groups (Schultz et al., 1993). Thus, anatomical connections exist that might explain the reward-related activity in SEF and ACC and the lack of such activity in the FEF. As described above, other anatomical studies have shown that SEF is interconnected with ACC much more heavily than is FEF (Huerta et al., 1987; Huerta and Kaas, 1990). ACC is considered to be the source of the ERN (Dehaene et al., 1994; Miltner et al., 1997). This might point to the ACC as the source of the error signals found in the SEF, but we have found no difference in the latency of the error signal in the two areas.

Regardless of the nature of the signal flow between SEF and ACC, the question remains, what type of mechanism can compute such an error signal. Three possibilities have been suggested. One class of model explains the error signal as the result of some form of mismatch detection between the intended and the actually performed behavior (Bernstein et al., 1995; Falkenstein et al., 2000). Models of this sort are challenged to explain



how intended actions are represented. Another class of model explains the error signal in terms of conflict-related activity, when the appropriate response becomes active just as the inappropriate response is executed (Carter et al., 1999; Botvinick et al., 2001; Gehring and Fencsik, 2001; Yeung et al., 2002). A virtue of this model is that it derives a measure of conflict from response preparation signals that must already be present. These two models—mismatch based and conflict based—make different predictions regarding the presence and magnitude of brain activation and the error-related negativity under different conditions that have been tested with divergent results (Bernstein et al., 1995; Scheffers et al., 1996; Holroyd et al., 1998; Scheffers and Coles, 2000; Coles et al., 2001; MacLeod et al., 1998; Gehring and Fencsik, 2001; Luu et al., 2000). A third class of model supposes that dopaminergic signals from the midbrain produce the error signal (Holroyd and Coles, 2002). This model is based on the observation that dopamine cells exhibit a transient reduction of activity when an unexpected error occurs, and the timing of this activity (Schultz, 1998) coincides with the timing of error signals observed in the error-related negativity. Modeling extrinsic control signals in the medial frontal lobe as originating in dopaminergic signals from the midbrain provides a connection to other models. A variety of models have sought to explain how the signal observed in dopaminergic neurons can be computed on the basis of primary reinforcers. Most of these focus on the temporal difference algorithm (Montague et al., 1996; Schultz et al., 1997; Suri and Schultz, 1999; Schultz, 2002 [this issue of *Neuron*]). However, a recent modeling study of dopamine afferents suggests that the neural circuits that learn and compute the dopamine signal may do so without an explicit temporal difference computation (Brown et al., 1999).

It should be noted that the three models are not mutually exclusive. No evidence conclusively excludes the possibility that dopaminergic as well as other cortical afferents could produce error-related activity. Also, because dopamine provides a reinforcement signal that modulates learning in the cerebral cortex (Bao et al., 2001) as well as in the basal ganglia (Reynolds et al., 2001; Wickens et al., 1996), dopamine may both drive error responses and also train the medial frontal areas to respond selectively to errors detected on the basis of corticocortical inputs.

Perhaps the diverse kinds of neural signals that we have observed in SEF and ACC may provide a reconciliation of these competing hypotheses. We found that neurons exhibiting error-related activity were *not* active in trials in which conflict between gaze-shifting and gaze-holding was most pronounced (trials when the planned movement was canceled), but error-related activity was observed in trials in which *no conflict* was present because the gaze-holding neurons were not modulated (trials when the movement was produced in spite of the stop signal) (Hanes et al., 1998; Stuphorn et al., 2000). This indicates that the error-related and conflict-related signals may arise from distinct populations of neurons in the medial frontal lobe. If this is so, then the search for an exclusive distinction between error-based and conflict-based models may be misguided.

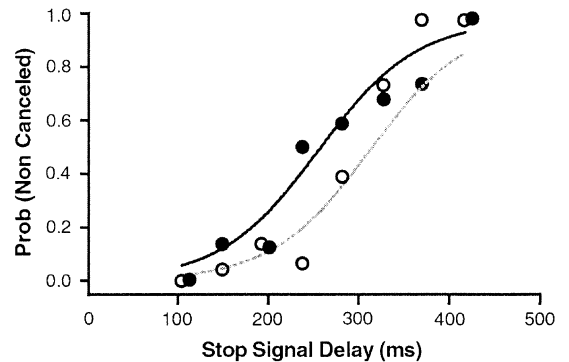

Figure 10. Effect of Weak Microstimulation of SEF on Saccade Countermanding Performance

Plot of probability of failing to cancel the saccade following the stop signal on trials without (filled) and with (open) microstimulation of a representative site in SEF. The curves are maximum likelihood fits of a logistic regression function with stop signal delay and presence (solid) or absence (dotted) of microstimulation as statistically significant factors. The rightward shift of the curve on trials with microstimulation indicates that the monkey was better able to withhold the planned movement.

#### Influence of Medial Frontal Lobe on Performance

Current work with humans has shown convincingly that the medial frontal lobe can detect error or conflict, but results are less clear about whether these signals can influence behavior (e.g., Gehring and Knight, 2000). We have described performance monitoring signals in SEF and ACC. The SEF but not the ACC has anatomical connections that position it to influence saccade production through projections to the FEF (e.g., Schall et al., 1993), the basal ganglia (Parthasarathy et al., 1992), superior colliculus (Fries, 1984; Shook et al., 1990; Huerta and Kaas, 1990), and brainstem (Shook et al., 1990; Huerta and Kaas, 1990). These connections are not potent enough for SEF to produce saccades directly (Schiller et al., 1980), but we hypothesize that these connections enable SEF to influence saccade generation by providing biasing signals to the ocular motor system.

To test this hypothesis, we examined whether intracortical microstimulation of SEF influenced performance in the countermanding task (V. Stuphorn et al., 2001, Soc. Neurosci., abstract). Electrical stimulation was delivered simultaneously with the presentation of the stop signal, at a current level well below the threshold for eliciting a saccade. The influence of this stimulation on performance was measured by comparing the fraction of non-canceled trials with and without stimulation. Preliminary evidence indicates that microstimulation of some sites in SEF improved performance by reducing the fraction of non-canceled saccades resulting in a delayed inhibition function (Figure 10).

What is the mechanism of this improvement in performance? A control signal can influence performance by applying a bias to the race process underlying countermanding performance. In other words, fewer non-canceled saccades would be produced if the GO process were slower or if the STOP process were faster. These alternatives can be distinguished by examining the distribution of the response times of the non-canceled sac-

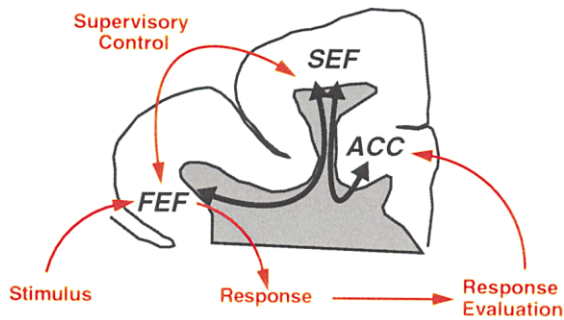

Figure 11. Summary Diagram of Major Anatomical Connections between (Black Arrows) and Hypothesized Functions of the Frontal Eye Field, Supplementary Eye Field, and Anterior Cingulate Cortex (Red Arrows)

cedes. If the GO process were slowed, then the non-canceled saccades should have longer latencies. If the STOP process were faster, then the non-canceled saccades should have unchanged latencies on microstimulation trials. The evidence indicates that the latencies of erroneous non-canceled saccades are somewhat longer following stimulation of sites in SEF. This result shows that the improvement of the performance is achieved by delaying saccade production, thereby allowing the STOP process more time to cancel the partially prepared saccade. This result is consistent with the observation that neurons in SEF are more active when reflexive saccades must be suppressed to produce antisaccades (Schlag-Rey et al., 1997).

### Summary and Avenues for Future Research

Single-unit recordings in macaque monkeys performing a saccade countermanding task indicate that the FEF in the lateral frontal cortex and the SEF and ACC in the medial frontal cortex seem to belong to two different functional systems. FEF, in concert with a network including the superior colliculus, generates signals sufficient to select targets and initiate the generation of eye movements. In contrast, the medial frontal areas do not appear to be involved in the primary control of eye movements. Instead, they seem to monitor performance, registering whether the actions that are produced lead to the desired consequences. Anatomical tracing studies have shown that the FEF and the SEF have strong reciprocal connections as do the SEF and the ACC, but the FEF and the ACC are only weakly connected. These findings led to our working hypothesis that the medial frontal cortex is part of a supervisory control system (Figure 11). The results of SEF microstimulation indicate that supervisory control signals can bias saccade preparation, closing the loop between the two control systems. This control enables the agent to achieve a more adaptive match between behavior and the ever-changing demands of the environment.

Obviously, this scheme is oversimplified, but the results and insights we have reviewed suggest a line of research that is likely to be fruitful. The issues we would explore include the following.

First, how is the initiation of a saccade controlled? The ultimate switch is the balance of activation in the

push-pull network of burst neurons and omnipause neurons in the brainstem (Scudder et al., 2002). Therefore, it will be instructive to record activity of these neurons during the countermanding task. Furthermore, a paradox confronts us. Thousands of neurons are necessary to produce a saccade, but the averaged signal from no more than ten is sufficient to specify whether and when gaze will shift. This paradox can be resolved only through simultaneous recording of presaccadic activity in multiple neurons throughout the saccade-generating circuit to clarify the mechanisms by which activity is coordinated.

Second, if SEF activation does delay saccade production, how is this influence exerted? This can be tested by recording in structures like FEF or the superior colliculus while electrical stimulation is delivered to SEF. Also, additional work is needed to determine whether electrical stimulation of the ACC has the same effect and potency as stimulation of the SEF.

Third, further effort is needed to work out the relationship of error, conflict, and reinforcement signals and the conceptual frameworks they inhabit. Are they distinct signals or different facets of the same signal? This can be approached in part through further model building that will sharpen these concepts as well as empirical investigations of neural signals in a wider variety of tasks.

Fourth, the hypothesis that SEF is a node in a supervisory executive network needs to be reconciled with data showing other functions of the SEF such as conditional motor learning, production of saccades with arbitrary stimulus-response mappings, as well as eye-hand coordination. The conceptual framework of executive control may unify these diverse observations. Current theories cite five types of behavior that require executive control—planning or decision making, error correction, producing responses that are not well learned, dealing with difficult or risky conditions, and overcoming habitual responses. These categories seem to capture the conditions under which various investigators have reported neural activity in supplementary eye field. Still, our observations were made under the very particular conditions of the saccade countermanding task with a foveal stop signal. The appearance of the foveal stop signal directly activates the ocular motor fixation system (e.g., Munoz and Wurtz, 1993; Everling et al., 1998), and thus produces what amounts to reflexive stopping. It should be noted that the stop signal reaction time of  $\sim 100$  ms measured in this condition is notably shorter than the  $\sim 200$  ms stop signal reaction times measured in other tasks (Logan and Cowan, 1984). Thus, to provide more direct comparisons to the human literature, unit recordings in the medial frontal lobe of monkeys performing Stroop-like and flanker competition tasks is needed (e.g., Lauwereyns et al., 2000; Sakagami et al., 2001). The most definitive data would require recording from a given neuron while a monkey performs a range of different tasks. The limits on monkey behavior, challenges of long-term neural recording stability, and the large number of trials needed conspire against accomplishing this in the foreseeable future.

Finally, this work has highlighted the relation of control and reinforcement. Experience of control through regular contingencies between actions and consequences

leads to beneficial effects, and in fact, both animal and human subjects prefer earning reinforcers under controlled conditions as opposed to noncontingent free delivery (reviewed by Mineka and Hendersen, 1985). As a matter of fact, the very potent rewarding effect of electrical stimulation of the medial forebrain bundle in the lateral hypothalamus (Olds and Milner, 1954) depends on control. The reinforcement value of the electrical stimulation is reduced if the time of its delivery is uncertain (Cantor and LoLordo, 1972). In fact, rats will work to avoid electrical stimulation of “reward sites” if it is delivered in a noncontingent manner (e.g., Steiner et al., 1969; Tsang and Stutz, 1984). If effectiveness of reinforcement is contingent on control, how is control sensed? This question may suggest why error and conflict signals are found with reinforcement signals in the medial frontal lobe.

#### Acknowledgments

Our research has been supported by NIH grants R01-MH55806, P30-EY08126, and the McKnight Endowment Fund for Neuroscience. J.D.S. is a Kennedy Center Investigator. V.S. was supported by a DFG research fellowship (STU 272/1-1).

#### References

Allport, D.A., Styles, E.A., and Hsieh, S. (1994). Shifting intentional set. Exploring the dynamic control of tasks. Conscious and nonconscious information processing. In *Attention and Performance 15*, C. Umiltà MM, ed. (Cambridge, MA: MIT).

Amador, N., Schlag-Rey, M., and Schlag, J. (2000). Reward-predicting and reward-detecting neuronal activity in the primate supplementary eye field. *J. Neurophysiol.* *84*, 2166–2170.

Asrress, K.N., and Carpenter, R.H. (2001). Saccadic countermanding: A comparison of central and peripheral stop signals. *Vision Res.* *41*, 2645–2651.

Aston-Jones, G., Rajkowski, J., Kubiak, P., and Alexinsky, T. (1994). Locus coeruleus neurons in monkey are selectively activated by attended cues in a vigilance task. *J. Neurosci.* *14*, 4467–4480.

Baddeley, A., and Della Sala, S. (1996). Working memory and executive control. *Philos. Trans. R. Soc. Lond. B Biol. Sci.* *351*, 1397–1403.

Bao, S., Chan, V.T., and Merzenich, M.M. (2001). Cortical remodeling induced by activity of ventral tegmental dopamine neurons. *Nature* *412*, 79–83.

Barch, D.M., Braver, T.S., Sabb, F.W., and Noll, D.C. (2000). The anterior cingulate cortex and response competition: Evidence from an fMRI study of overt verb generation. *J. Cogn. Neurosci.* *12*, 298–305.

Becker, W., and Jurgens, R. (1979). An analysis of the saccadic system by means of double step stimuli. *Vision Res.* *19*, 967–983.

Bernstein, P.S., Scheffers, M.K., and Coles, M.G. (1995). “Where did I go wrong?” A psychophysiological analysis of error detection. *J. Exp. Psychol. Hum. Percept. Perform.* *21*, 1312–1322.

Bichot, N.P., and Schall, J.D. (1999a). Effects of similarity and history on neural mechanisms of visual selection. *Nat. Neurosci.* *2*, 549–554.

Bichot, N.P., and Schall, J.D. (1999b). Saccade target selection in macaque during feature and conjunction visual search. *Vis. Neurosci.* *16*, 81–89.

Bichot, N.P., and Schall, J.D. (2002). Priming in macaque frontal cortex during popout visual search: Feature-based facilitation and location-based inhibition of return. *J. Neurosci.* *22*, 4675–4685.

Bichot, N.P., Thompson, K.G., Chenchal Rao, S., and Schall, J.D. (2001). Reliability of macaque frontal eye field neurons signaling saccade targets during visual search. *J. Neurosci.* *21*, 713–725.

Botvinick, M.M., Braver, T.S., Barch, D.M., Carter, C.S., and Cohen,

J.C. (2001). Conflict monitoring and cognitive control. *Psychol. Rev.* *108*, 624–652.

Brown, J., Bullock, D., and Grossberg, S. (1999). How the basal ganglia use parallel excitatory and inhibitory learning pathways to selectively respond to unexpected rewarding cues. *J. Neurosci.* *19*, 10502–10511.

Bruce, C.J., and Goldberg, M.E. (1985). Primate frontal eye fields. I. Single neurons discharging before saccades. *J. Neurophysiol.* *53*, 603–635.

Bruce, C.J., Goldberg, M.E., Bushnell, C., and Stanton, G.B. (1985). Primate frontal eye fields. II. Physiological and anatomical correlates of electrically evoked eye movements. *J. Neurophysiol.* *54*, 714–734.

Bush, G., Luu, P., and Posner, M.I. (2000). Cognitive and emotional influences in anterior cingulate cortex. *Trends Cogn. Sci.* *4*, 215–222.

Cabel, D.W., Armstrong, I.T., Reingold, E., and Munoz, D.P. (2000). Control of saccade initiation in a countermanding task using visual and auditory stop signals. *Exp. Brain Res.* *133*, 431–441.

Cantor, M.B., and LoLordo, V.M. (1972). Reward value of brain stimulation is inversely related to uncertainty about its onset. *J. Comp. Physiol. Psychol.* *79*, 259–270.

Carpenter, R.H.S. (1988). *Movements of the Eyes* (London: Pion).

Carpenter, R.H.S. (1991). *Eye Movements* (London: Macmillan).

Carpenter, R.H.S., and Williams, M.L.L. (1995). Neural computation of log likelihood in the control of saccadic eye movements. *Nature* *377*, 59–62.

Carter, C.S., Botvinick, M.M., and Cohen, J.D. (1999). The contribution of the anterior cingulate cortex to executive processes in cognition. *Rev. Neurosci.* *10*, 49–57.

Carter, C.S., Braver, T.S., Barch, D.M., Botvinick, M.M., Noll, D., and Cohen, J.D. (1998). Anterior cingulate cortex, error detection and the online monitoring of performance. *Science* *280*, 747–749.

Chen, L.L., and Wise, S.P. (1995). Neuronal activity in the supplementary eye field during acquisition of conditional oculomotor associations. *J. Neurophysiol.* *73*, 1101–1121.

Cohen, J.D., Dunbar, K., and McClelland, J.L. (1990). On the control of automatic processes: A parallel distributed processing account of the Stroop effect. *Psychol. Rev.* *97*, 332–361.

Colby, C.L., and Goldberg, M.E. (1999). Space and attention in parietal cortex. *Annu. Rev. Neurosci.* *22*, 319–349.

Coles, M.G.H., Scheffers, M.K., and Fournier, L. (1995). Where did you go wrong? Errors, partial errors and the nature of human information processing. *Acta Psychol. (Amst.)* *90*, 129–144.

Coles, M.G., Scheffers, M.K., and Holroyd, C.B. (2001). Why is there an ERN/Ne on correct trials? Response representations, stimulus-related components, and the theory of error-processing. *Biol. Psychol.* *56*, 173–189.

Colonus, H., Ozyurt, J., and Arndt, P.A. (2001). Countermanding saccades with auditory stop signals: testing the race model. *Vision Res.* *41*, 1951–1968.

Dehaene, S., Posner, M.I., and Tucker, D.M. (1994). Localization of a neural system for error detection and compensation. *Psychol. Sci.* *5*, 303–305.

Dias, E.C., Kiesau, M., and Segraves, M.A. (1995). Acute activation and inactivation of macaque frontal eye field with GABA-related drugs. *J. Neurophysiol.* *74*, 2744–2748.

Dorris, M.C., Paré, M., and Munoz, D.P. (1997). Neuronal activity in monkey superior colliculus related to the initiation of saccadic eye movements. *J. Neurosci.* *17*, 8566–8579.

Dorris, M.C., Paré, M., and Munoz, D.P. (2000). Immediate neural plasticity shapes motor performance. *J. Neurosci.* *20*, RC52.

Dum, R.P., and Strick, P.L. (1991). The origin of corticospinal projections from the premotor areas in the frontal lobe. *J. Neurosci.* *11*, 667–689.

Everling, S., and Munoz, D.P. (2000). Neuronal correlates for preparatory set associated with pro-saccades and anti-saccades in the primate frontal eye field. *J. Neurosci.* *20*, 387–400.

Everling, S., Paré, M., Dorris, M.C., and Munoz, D.P. (1998). Comparison of the discharge characteristics of brain stem omnipause neu-

- rons and superior colliculus fixation neurons in monkey: implications for control of fixation and saccade behavior. *J. Neurophysiol.* 79, 511–528.
- Everling, S., Dorris, M.C., Klein, R.M., and Munoz, D.P. (1999). Role of primate superior colliculus in preparation and execution of anti-saccades and pro-saccades. *J. Neurosci.* 19, 2740–2754.
- Exner, S. (1873). Experimentelle Untersuchung der einfachsten psychischen Prozesse. *Pflüger's Archiv. für gesamte Physiologie* 7, 601–660. In *The Principles of Psychology*, W. James, transl. (1890/1950). (New York: Dover Publications Inc.), p. 92.
- Falkenstein, M., Hohnsbein, J., and Hoormann, J. (1991). Effects of cross-modal divided attention on late ERP components: II. Error processing in choice reaction tasks. *Electroencephalogr. Clin. Neurophysiol.* 78, 447–455.
- Falkenstein, M., Hohnsbein, J., and Hoorman, J. (1995). Event related potential correlates of errors in reaction tasks. In *Perspectives of Event-Related Potentials Research*, G. Karmos, M. Molnar, V. Csepe, I. Czigner, and J.E. Desmedt, eds. (Amsterdam: Elsevier Science B.V.), pp. 287–296.
- Falkenstein, M., Hoormann, J., Christ, S., and Hohnsbein, J. (2000). ERP components on reaction errors and their functional significance: A tutorial. *Biol. Psychol.* 51, 87–107.
- Findlay, J.M. (1981). Spatial and temporal factors in the predictive generation of saccadic eye movements. *Vision Res.* 21, 347–354.
- Fries, W. (1984). Cortical projections to the superior colliculus in the macaque monkey: a retrograde study using horseradish peroxidase. *J. Comp. Neurol.* 230, 55–76.
- Gaspar, P., Stepniewska, I., and Kaas, J.H. (1992). Topography and collateralization of the dopaminergic projections to motor and lateral prefrontal cortex in owl monkeys. *J. Comp. Neurol.* 325, 1–21.
- Gaymard, B., Ploner, C.J., Rivaud, S., Vermersch, A.I., and Pierrot-Deseilligny, C. (1998). Cortical control of saccades. *Exp. Brain Res.* 123, 159–163.
- Gehring, W.J., and Knight, R.T. (2000). Prefrontal-cingulate interactions in action monitoring. *Nat. Neurosci.* 3, 516–520.
- Gehring, W.J., and Fencsik, D.E. (2001). Functions of the medial frontal cortex in the processing of conflict and errors. *J. Neurosci.* 21, 9430–9437.
- Gehring, W.J., Goss, B., Coles, M.G., and Meyer, D.E. (1993). A neural system for error detection and compensation. *Psychol. Sci.* 4, 385–390.
- Gemba, H., Sasaki, K., and Brooks, V.B. (1986). 'Error' potentials in limbic cortex (anterior cingulate area 24) of monkeys during motor learning. *Neurosci. Lett.* 70, 223–227.
- Glimcher, P.W. (2001). Making choices: The neurophysiology of visual-saccadic decision making. *Trends Neurosci.* 24, 654–659.
- Gold, J.I., and Shadlen, M.N. (2001). Neural computations that underlie decisions about sensory stimuli. *Trends Cogn. Sci.* 5, 10–16.
- Gold, J.I., and Shadlen, M.N. (2002). Banburismus and the brain: decoding the relationship between sensory stimuli, decisions, and reward. *Neuron* 36, this issue, 299–308.
- Gratton, G., Coles, M.G.H., Sirevaag, E.J., Eriksen, C.J., and Donchin, E. (1988). Pre- and poststimulus activation of response channels: A psychophysiological analysis. *J. Exp. Psychol. Hum. Percept. Perform.* 14, 331–344.
- Hanes, D.P., and Schall, J.D. (1995). Countermanding saccades in macaque. *Vis. Neurosci.* 12, 929–937.
- Hanes, D.P., and Schall, J.D. (1996). Neural control of voluntary movement initiation. *Science* 274, 427–430.
- Hanes, D.P., and Carpenter, R.H.S. (1999). Countermanding saccades in humans. *Vision Res.* 39, 2777–2791.
- Hanes, D.P., Patterson, W.F., and Schall, J.D. (1998). The role of frontal eye field in countermanding saccades: Visual, movement and fixation activity. *J. Neurophysiol.* 79, 817–834.
- Holroyd, C.B., and Coles, M.G.H. (2002). The neural basis of human error processing: Reinforcement learning, dopamine, and the error-related negativity. *Psychol. Rev.*, in press.
- Holroyd, C.B., Dien, J., and Coles, M.G. (1998). Error-related scalp potentials elicited by hand and foot movements: Evidence for an output-independent error-processing system in humans. *Neurosci. Lett.* 242, 65–68.
- Huerta, M.F., and Kaas, J.H. (1990). Supplementary eye field as defined by intracortical microstimulation: Connections in macaques. *J. Comp. Neurol.* 293, 299–330.
- Huerta, M.F., Krubitzer, L.A., and Kaas, J.H. (1987). Frontal eye field as defined by intracortical microstimulation in squirrel monkeys, owl monkeys and macaque monkeys. II. Cortical Connections. *J. Comp. Neurol.* 265, 332–361.
- Juarrero, A. (1999). *Dynamics in Action: Intentional Behavior as a Complex System* (Cambridge, MA: MIT Press).
- Kane, R. (1996). *The Significance of Free Will* (Oxford, New York: Oxford University Press).
- Kawagoe, R., Takikawa, Y., and Hikosaka, O. (1998). Expectation of reward modulates cognitive signals in the basal ganglia. *Nat. Neurosci.* 1, 411–416.
- Kim, J. (1998). *Mind in a Physical World: An Essay on the Mind-Body Problem and Mental Causation*. (Cambridge, MA: MIT Press).
- Kim, J.N., and Shadlen, M.N. (1999). Neural correlates of a decision in the dorsolateral prefrontal cortex of the macaque. *Nat. Neurosci.* 2, 176–185.
- Koski, L., and Paus, T. (2000). Functional connectivity of the anterior cingulate cortex within the human frontal lobe: a brain-mapping meta-analysis. *Exp. Brain Res.* 133, 55–65.
- Lauwereyns, J., Koizumi, M., Sakagami, M., Hikosaka, O., Kobayashi, S., and Tsutsui, K. (2000). Interference from irrelevant features on visual discrimination by macaques (*Macaca fuscata*): A behavioral analogue of the human Stroop effect. *J. Exp. Psychol. Anim. Behav. Process.* 26, 352–357.
- Lecas, J.-C., Requin, J., Anger, C., and Vitton, N. (1986). Changes in neuronal activity of the monkey precentral cortex during preparation for movement. *J. Neurophysiol.* 56, 1680–1702.
- Lee, C., Rohrer, W.H., and Sparks, D.L. (1988). Population coding of saccadic eye movements by neurons in the superior colliculus. *Nature* 332, 357–360.
- Lisberger, S.G., Fuchs, A.F., King, W.M., and Evinger, L.C. (1975). Effect of mean reaction time on saccadic responses to two-step stimuli with horizontal and vertical components. *Vision Res.* 15, 1021–1025.
- Logan, G.D. (1985). Executive control of thought and action. *Acta Psychol.* 60, 193–210.
- Logan, G.D. (1994). On the ability to inhibit thought and action: A user's guide to the stop signal paradigm. In *Inhibitory Processes in Attention, Memory, and Language*, D. Dagebach and T.H. Carr, eds. (San Diego, CA: Academic Press Inc.), pp. 189–239.
- Logan, G.D., and Cowan, W.B. (1984). On the ability to inhibit thought and action: A theory of an act of control. *Psychol. Rev.* 91, 295–327.
- Logan, G.D., and Irwin, D.E. (2000). Don't look! Don't touch! Inhibitory control of eye and hand movements. *Psychon. Bull. Rev.* 7, 107–112.
- Logan, G.D., and Gordon, R.D. (2001). Executive control of visual attention in dual-task situations. *Psychol. Rev.* 108, 393–434.
- Luce, R.D. (1986). *Response Times: Their Role in Inferring Elementary Mental Organization* (Oxford: Oxford University Press).
- Luppino, G., Matelli, M., and Rizzolatti, G. (1990). Cortico-cortical connections of two electrophysiologically identified arm representations in the mesial agranular frontal cortex. *Exp. Brain Res.* 82, 214–218.
- Luppino, G., Matelli, M., Camarda, R.M., Gallese, V., and Rizzolatti, G. (1991). Multiple representations of body movements in mesial area 6 and the adjacent cingulate cortex: An intracortical microstimulation study in the macaque monkey. *J. Comp. Neurol.* 311, 463–482.
- Lu, X., Matsuzawa, M., and Hikosaka, O. (2002). A neural correlate of oculomotor sequences in supplementary eye field. *Neuron* 34, 317–325.

- Luu, P., Flaisch, T., and Tucker, D.M. (2000). Medial frontal cortex in action monitoring. *J. Neurosci.* 20, 464–469.
- MacLeod, A.K., Buckner, R.L., Miezin, F.M., Peterson, S.E., and Raichle, M.E. (1998). Right anterior prefrontal cortex activation during semantic monitoring and working memory. *Neuroimage* 7, 41–48.
- Matelli, M., Rizzolatti, G., Bettinardi, V., Gilardi, M.C., Perani, D., Rizzo, G., and Fazio, F. (1993). Activation of precentral and mesial motor areas during the execution of elementary proximal and distal arm movements: a PET study. *Neuroreport* 4, 1295–1298.
- Miltner, W.H.R., Braun, C.H., and Coles, M.G.H. (1997). Event-related brain potentials following incorrect feedback in a time-estimation task: Evidence for a “generic” neural system for error detection. *J. Cogn. Neurosci.* 9, 787–797.
- Mineka, S., and Hendersen, R.W. (1985). Controllability and predictability in acquired motivation. *Annu. Rev. Psychol.* 36, 495–529.
- Mitz, A.R., and Wise, S.P. (1987). The somatotopic organization of the supplementary motor area: Intracortical microstimulation mapping. *J. Neurosci.* 7, 1010–1021.
- Mitz, A.R., and Godschalk, M. (1989). Eye-movement representation in the frontal lobe of rhesus monkeys. *Neurosci. Lett.* 106, 157–162.
- Mohler, C.W., Goldberg, M.E., and Wurtz, R.H. (1973). Visual receptive fields of frontal eye field neurons. *Brain Res.* 61, 385–389.
- Montague, P.R., Dayan, P., and Sejnowski, T. (1996). A framework for mesencephalic dopamine systems based on predictive Hebbian learning. *J. Neurosci.* 16, 1936–1947.
- Morecraft, R.J., and Van Hoesen, G.W. (1992). Cingulate input to the primary and supplementary motor cortices in the rhesus monkey: evidence for somatopy in areas 24c and 23c. *J. Comp. Neurol.* 322, 471–489.
- Munoz, D.P., and Wurtz, R.H. (1993). Fixation cells in monkey superior colliculus. I. Characteristics of cell discharge. *J. Neurophysiol.* 70, 559–575.
- Murthy, A., Thompson, K.G., and Schall, J.D. (2001). Dynamic dissociation of visual selection from saccade programming in FEF. *J. Neurophysiol.* 86, 2634–2637.
- Mushiaki, H., Fujii, N., and Tanji, J. (1996). Visually guided saccade versus eye-hand reach: contrasting neuronal activity in the cortical supplementary and frontal eye fields. *J. Neurophysiol.* 75, 2187–2191.
- Niemi, P., and Näätänen, R. (1981). Foreperiod and simple reaction time. *Psychol. Bull.* 89, 133–162.
- Niki, H., and Watanabe, M. (1976). Cingulate unit activity and delayed response. *Brain Res.* 110, 381–386.
- Niki, H., and Watanabe, M. (1979). Prefrontal and cingulate unit activity during timing behavior in the monkey. *Brain Res.* 171, 213–224.
- Norman, D., and Shallice, T. (1986). Attention to action: Willed and automatic control of behavior. In *Consciousness and Self Regulation: Advances in Research and Theory*, R. Davidson, G. Schwartz, and D. Shapiro, eds. (New York: Plenum), pp 1–18.
- Olds, J., and Milner, P.M. (1954). Positive reinforcement produced by electrical stimulation of septal area and other regions of rat brain. *J. Comp. Physiol. Psychol.* 47, 419–427.
- Olson, C.R., and Gettner, S.N. (1995). Object-centered direction selectivity in the macaque supplementary eye field. *Science* 269, 985–988.
- Olson, C.R., and Gettner, S.N. (1996). Representation of object-centered space in the primate frontal lobe. *Brain Res. Cogn. Brain Res.* 5, 147–156.
- Olson, C.R., and Gettner, S.N. (1999). Macaque SEF neurons encode object-centered directions of eye movements regardless of the visual attributes of instructional cues. *J. Neurophysiol.* 81, 2340–2346.
- Olson, C.R., and Tremblay, L. (2000). Macaque supplementary eye field neurons encode object-centered locations relative to both continuous and discontinuous objects. *J. Neurophysiol.* 83, 2392–2411.
- O’Sullivan, E.P., Jenkins, I.H., Henderson, L., Kennard, C., and Brooks, D.J. (1995). The functional anatomy of remembered saccades: a PET study. *Neuroreport* 6, 2141–2144.
- Parker, A.J., and Newsome, W.T. (1998). Sense and the single neuron: Probing the physiology of perception. *Annu. Rev. Neurosci.* 21, 227–277.
- Parthasarathy, H.B., Schall, J.D., and Graybiel, A.M. (1992). Distributed but convergent ordering of corticostriatal projections: Analysis of the frontal eye field and the supplementary eye field in the macaque monkey. *J. Neurosci.* 12, 4468–4488.
- Paus, T., Petrides, M., Evans, A.C., and Meyer, E. (1993). Role of the human anterior cingulate cortex in the control of oculomotor, manual, and speech responses: A positron emission tomography study. *J. Neurophysiol.* 70, 453–469.
- Paus, T., Tomaiuolo, F., Otaky, N., MacDonald, D., Petrides, M., Atlas, J., Morris, R., and Evans, A.C. (1996). Human cingulate and paracingulate sulci: Pattern, variability, asymmetry, and probabilistic map. *Cereb. Cortex* 6, 207–214.
- Petit, L., Courtney, S.M., Ungerleider, L.G., and Haxby, J.V. (1998). Sustained activity in the medial wall during working memory delays. *J. Neurosci.* 18, 9429–9437.
- Picard, N., and Strick, P.L. (1996). Motor areas of the medial wall: a review of their location and functional activation. *Cereb. Cortex* 6, 342–353.
- Platt, M.L., and Glimcher, P.W. (1999). Neural correlates of decision variables in parietal cortex. *Nature* 400, 233–238.
- Posner, M.I., and DiGirolamo, G.J. (1998). Executive attention: Conflict, target detection and cognitive control. In *The Attentive Brain*, R. Parasuraman, ed. (Cambridge, MA: MIT Press), pp. 401–423.
- Procyk, E., Tanaka, Y.L., and Joseph, J.P. (2000). Anterior cingulate activity during routine and non-routine sequential behaviors in macaques. *Nat. Neurosci.* 3, 502–508.
- Rabbitt, P.M.A. (1966). Errors and error-correction in choice-response tasks. *J. Exp. Psychol.* 71, 264–272.
- Rabbitt, P.M., and Phillips, S. (1967). Error-detection and correction latencies as a function of S-R compatibility. *J. Exp. Psychol.* 19, 37–42.
- Ratcliff, R. (1978). A theory of memory retrieval. *Psychol. Rev.* 85, 59–108.
- Ratcliff, R., Van Zandt, T., and McKoon, G. (1999). Connectionist and diffusion models of reaction time. *Psychol. Rev.* 106, 261–300.
- Reddi, B.A., and Carpenter, R.H. (2000). The influence of urgency on decision time. *Nat. Neurosci.* 3, 827–830.
- Reynolds, J.N., Hyland, B.I., and Wickens, J.R. (2001). A cellular mechanism of reward-related learning. *Nature* 413, 67–70.
- Rolls, E.T. (1999). *The Brain and Emotion* (Oxford: Oxford University Press).
- Russo, G.S., and Bruce, C.J. (1996). Neurons in the supplementary eye field of rhesus monkeys code visual targets and saccadic eye movements in an oculocentric coordinate system. *J. Neurophysiol.* 76, 825–848.
- Sakagami, M., Tsutsui, K.i., Lauwereyns, J., Koizumi, M., Kobayashi, S., and Hikosaka, O. (2001). A code for behavioral inhibition on the basis of color, but not motion, in ventrolateral prefrontal cortex of macaque monkey. *J. Neurosci.* 21, 4801–4808.
- Sato, T., Murthy, A., Thompson, K.G., and Schall, J.D. (2001). Effect of search efficiency but not response interference on visual selection in FEF. *Neuron* 30, 583–591.
- Schall, J.D. (1991). Neuronal activity related to visually guided saccadic eye movements in the supplementary motor area of rhesus monkeys. *J. Neurophysiol.* 66, 530–558.
- Schall, J.D. (1997). Visuomotor areas of the frontal lobe. In *Extrastriate Cortex of Primates, Volume 12 of Cerebral Cortex*, K. Rockland, A. Peters, and J. Kaas, eds., (New York: Plenum), pp. 527–638.
- Schall, J.D. (2001). Neural basis of deciding, choosing and acting. *Nat. Rev. Neurosci.* 2, 33–42.
- Schall, J.D., and Thompson, K.G. (1999). Neural selection and control of visually guided eye movements. *Annu. Rev. Neurosci.* 22, 241–259.
- Schall, J.D., Morel, A., and Kaas, J.H. (1993). Topography of supplementary eye field afferents to frontal eye field in macaque: Implica-

- tions for mapping between saccade coordinate systems. *Vis. Neurosci.* 10, 385–393.
- Schall, J.D., Hanes, D.P., Thompson, K.G., and King, D.J. (1995). Saccade target selection in frontal eye field of macaque. I. Visual and premovement activation. *J. Neurosci.* 15, 6905–6918.
- Scheffers, M.K., and Coles, M.G. (2000). Performance monitoring in a confusing world: Error-related brain activity, judgments of response accuracy, and types of errors. *J. Exp. Psychol. Hum. Percept. Perform.* 26, 141–151.
- Scheffers, M.K., Coles, M.G., Bernstein, P., Gehring, W.J., and Donchin, E. (1996). Event-related brain potentials and error-related processing: an analysis of incorrect responses to go and no-go stimuli. *Psychophysiology* 33, 42–53.
- Schiller, P.H., and Chou, I.-H. (1998). The effects of frontal eye field and dorsomedial frontal cortex lesions on visually guided eye movements. *Nat. Neurosci.* 1, 248–253.
- Schiller, P.H., and Chou, I. (2000a). The effects of anterior arcuate and dorsomedial frontal cortex lesions on visually guided eye movements in the rhesus monkey: 1. Single and sequential targets. *Vision Res.* 40, 1609–1626.
- Schiller, P.H., and Chou, I. (2000b). The effects of anterior arcuate and dorsomedial frontal cortex lesions on visually guided eye movements: 2. Paired and multiple targets. *Vision Res.* 40, 1627–1638.
- Schiller, P.H., True, S.D., and Conway, J.D. (1980). Deficits in eye movements following frontal eye field and superior colliculus ablations. *J. Neurophysiol.* 44, 1175–1189.
- Schiller, P.H., Sandell, J.H., and Maunsell, J.H.R. (1987). The effect of frontal eye field and superior colliculus lesions on saccadic latencies in the rhesus monkey. *J. Neurophysiol.* 57, 1033–1049.
- Schlag, J., and Schlag-Rey, M. (1987). Evidence for a supplementary eye field. *J. Neurophysiol.* 57, 179–200.
- Schlag-Rey, M., Amador, N., Sanchez, H., and Schlag, J. (1997). Antisaccade performance predicted by neuronal activity in the supplementary eye field. *Nature* 390, 398–401.
- Schultz, W. (1997). Dopamine neurons and their role in reward mechanisms. *Curr. Opin. Neurobiol.* 7, 191–197.
- Schultz, W. (1998). Predictive reward signal of dopamine neurons. *J. Neurophysiol.* 80, 1–27.
- Schultz, W. (2002). Getting formal with dopamine and reward. *Neuron* 36, this issue, 241–263.
- Schultz, W., and Dickinson, A. (2000). Neuronal coding of prediction errors. *Annu. Rev. Neurosci.* 23, 473–500.
- Schultz, W., Apicella, P., and Ljungberg, T. (1993). Responses of monkey dopamine neurons to reward and conditioned stimuli during successive steps of learning a delayed response task. *J. Neurosci.* 13, 900–913.
- Schultz, W., Dayan, P., and Montague, P.R. (1997). A neural substrate of prediction and reward. *Science* 275, 1593–1599.
- Scudder, C.A., Kaneko, C.S., and Fuchs, A.F. (2002). The brainstem burst generator for saccadic eye movements: A modern synthesis. *Exp. Brain Res.* 142, 439–462.
- Segraves, M.A. (1992). Activity of monkey frontal eye field neurons projecting to oculomotor regions of the pons. *J. Neurophysiol.* 68, 1967–1985.
- Segraves, M.A., and Goldberg, M.E. (1987). Functional properties of corticotectal neurons in the monkey's frontal eye fields. *J. Neurophysiol.* 58, 1387–1419.
- Shadlen, M.N., Britten, K.H., Newsome, W.T., and Movshon, J.A. (1996). A computational analysis of the relationship between neuronal and behavioral responses to visual motion. *J. Neurosci.* 16, 1486–1510.
- Shidara, M., Aigner, T.G., and Richmond, B.J. (1998). Neuronal signals in the monkey ventral striatum related to progress through a predictable series of trials. *J. Neurosci.* 18, 2613–2625.
- Shima, K., and Tanji, J. (1998). Role of cingulate motor area cells in voluntary movement selection based on reward. *Science* 282, 1335–1338.
- Shima, K., Aya, K., Mushiake, H., Inase, M., Aizawa, H., and Tanji, J. (1991). Two movement-related foci in the primate cingulate cortex observed in signal-triggered and self-paced forelimb movements. *J. Neurophysiol.* 65, 188–202.
- Shook, B.L., Schlag-Rey, M., and Schlag, J. (1990). Primate supplementary eye field: I. Comparative aspects of mesencephalic and pontine connections. *J. Comp. Neurol.* 301, 618–642.
- Shook, B.L., Schlag-Rey, M., and Schlag, J. (1991). Primate supplementary eye field. II. Comparative aspects of connections with the thalamus, corpus striatum, and related forebrain nuclei. *J. Comp. Neurol.* 307, 562–583.
- Sommer, M.A., and Tehovnik, E.J. (1997). Reversible inactivation of macaque frontal eye field. *Exp. Brain Res.* 116, 229–249.
- Sommer, M.A., and Wurtz, R.H. (2000). Composition and topographic organization of signals sent from the frontal eye field to the superior colliculus. *J. Neurophysiol.* 83, 1979–2001.
- Sparks, D.L. (1978). Functional properties of neurons in the monkey superior colliculus: Coupling of neuronal activity and saccade onset. *Brain Res.* 156, 1–16.
- Stanton, G.B., Bruce, C.J., and Goldberg, M.E. (1993). Topography of projections to the frontal lobe from the macaque frontal eye fields. *J. Comp. Neurol.* 330, 286–301.
- Steiner, S.S., Beer, B., and Shaffer, M.M. (1969). Escape from self-produced rates of brain stimulation. *Science* 163, 90–91.
- Sternberg, S., Monsell, S., Knoll, R.L., and Wright, C.E. (1978). The latency and duration of rapid movement sequences: Comparisons of speech and type writing. In *Information Processing in Motor Control*, G.E. Stelmach, ed. (New York: Academic Press).
- Stuphorn, V., Taylor, T.L., and Schall, J.D. (2000). Performance monitoring by the supplementary eye field. *Nature* 408, 857–860.
- Suri, R.E., and Schultz, W. (1999). A neural network model with dopamine-like reinforcement signal that learns a spatial delayed response task. *Neuroscience* 91, 871–890.
- Sutton, R.S., and Barto, A.G. (1998). *Reinforcement Learning* (Cambridge, MA: MIT Press).
- Tehovnik, E.J., and Lee, K. (1993). The dorsomedial frontal cortex of the rhesus monkey: Topographic representation of saccades evoked by electrical stimulation. *Exp. Brain Res.* 96, 430–442.
- Thompson, K.G., and Schall, J.D. (1999). The detection of visual signals by macaque frontal eye field during masking. *Nat. Neurosci.* 2, 283–288.
- Thorpe, S.J., Rolls, E.T., and Maddison, S. (1983). The orbitofrontal cortex: Neuronal activity in the behaving monkey. *Exp. Brain Res.* 49, 93–115.
- Tsang, W.K., and Stutz, R.M. (1984). Subject control as a determinant of the reinforcing properties of intracranial stimulation. *Physiol. Behav.* 32, 795–802.
- Watanabe, M. (1996). Reward expectancy in primate prefrontal neurons. *Nature* 382, 629–632.
- Wickens, J.R., Begg, A.G., and Arbuthnott, G.W. (1996). Dopamine reverses the depression of rat corticostriatal synapses which normally follows high frequency stimulation of cortex in vitro. *Neuroscience* 70, 1–5.
- Williams, S.M., and Goldman-Rakic, P.S. (1998). Widespread origin of the primate mesofrontal dopamine system. *Cereb. Cortex* 8, 321–345.
- Wurtz, R.H., and Goldberg, M.E. (1989). *The Neurobiology of Saccadic Eye Movements* (New York: Elsevier).
- Wurtz, R.H., Sommer, M.A., Paré, M., and Ferraina, S. (2001). Signal transformations from cerebral cortex to superior colliculus for the generation of saccades. *Vision Res.* 41, 3399–3412.
- Yeung, N., Botvinick, M.M., and Cohen, J.D. (2002). The neural basis of error detection: Conflict monitoring and the error-related negativity. *Psychol. Rev.*
- Zingale, C.M., and Kowler, E. (1987). Planning sequences of saccades. *Vision Res.* 27, 1327–1341.